

Varenummer: 03449180
 Beskrivelse: Fluro Heavy Duty Ledleje GE 180 SWE
 Hul Ø180
 Note: 180

Mål

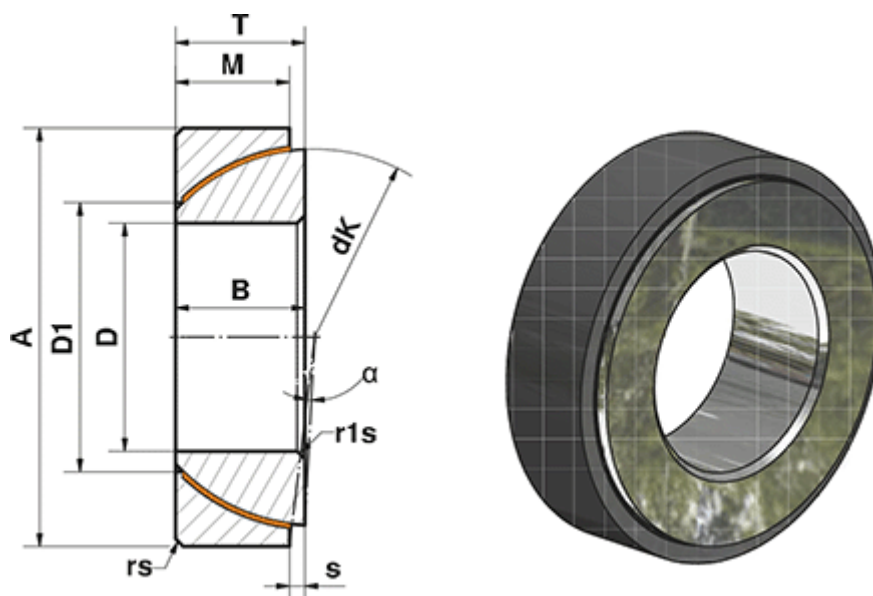

A	= 280	rs, r1s min	= 3
a (grader)	= 1	S	= 21
B	= 64	Statisk belastning C0 (kN)	= 6536
D	= 180	T	= 64
D1	= 206.4	Vægt (g)	= 17400
dK	= 260		
Dynamisk belastning C (kN)	= 3922		
M	= 61		